

Assessment Interoperability Framework

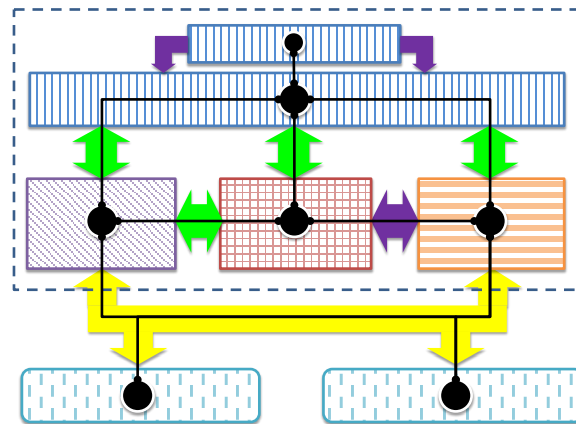

Best Practices Documentation

Table of Contents

- 1. Introduction4**
- 1.1. Scope and Context.....4
 - 1.1.1. Relationship to other Standards 5
 - 1.1.2. Features..... 6
 - 1.1.3. Business Case..... 7
- 1.2. Structure of the Document.....7
- 1.3. References.....7
- 2. Constructing a Solution9**
- 2.1. Learning Standards 9
 - 2.1.1. Learning Standard Annotation in APIP..... 9
- 2.2. Authoring Content and Item Banking..... 12
 - 2.2.1. Authoring Recommendations.....12
 - 2.2.2. Item Bank/Assessment System APIP Interoperability Architecture13
 - 2.2.3. Item Bank APIP APIs.....14
- 2.3. Test Banking..... 15
 - 2.3.1. Authoring Recommendations.....15
 - 2.3.2. Test Bank APIP Interoperability Architecture.....15
 - 2.3.3. Test Bank APIP APIs.....16
 - 2.3.4. Authoring System APIP APIs.....18
- 2.4. Assessment Presentation and Session Management System19
 - 2.4.1. Assessment Delivery System APIP Interoperability Architecture19
 - 2.4.2. Preferences Server APIP APIs20
 - 2.4.3. Assessment Delivery System APIP APIs20
- 2.5. Assessment Registration and Administration System.....21
 - 2.5.1. PNP Provision for the ARAS.....21
 - 2.5.2. SIF Provision for ARAS23
- Data Flow23
- 2.5.3. PNP XML Example.....23
- 2.6. Assessment Scoring Management System.....26
 - 2.6.1. SIF Provision for Scoring27
- Data Flow27
- 2.7. Assessment Results Operational Reporting28
 - 2.7.1. Data Flow.....29
 - 2.7.2. Example XML Code29
- 2.8. Assessment Data Warehouse.....30
 - Data Flow31
- 2.9. Local: SIS, LMS, Grade Book, Reporting System.....31
 - Data Flow31
- 2.10. State/Consortia: SLDS, Accountability/AYP, Growth.....32
- 3. Supporting the Use Cases33**
- 3.1. Assessment Item Bank Interoperability (Arrow 1) 33
 - Export Package Creation.....33
 - Export of Package.....33
 - Package Receipt and Verification33
 - Package Import34

Demonstration Workflow34

3.2. Assessment Registration (Arrow 10) 35

Export Student Data.....36

Receipt and Data Quality Verification36

Input PNP Data.....36

Create Registration.....36

3.3. Assessment Results Distribution to State Information Systems (Arrow 14)..... 36

Export Student Results.....37

Receipt and Data Quality Verification37

4. Acronyms and Glossary38

1. Introduction

1.1. Scope and Context

To date, a lack of accepted data standards has limited states' and districts' abilities to use the most innovative assessment systems. As they develop next-generation assessment systems, states in the Race to the Top Assessment consortia and General Supervision Enhancement Grant consortia need to establish such standards to facilitate item and data transfer across systems and across states. Utilizing open technical standards, developed through the CEDS assessment standards process, will give states in the consortia the greatest opportunity to continue to innovate during and after the grant period without losing access to items or data.

The CEDS team leveraged existing standards work done by the IMS Global Consortium (IMS) and SIF Association (SIF) communities and worked with both organizations to create the new assessment entities and elements. CEDS contains the domains, entities and elements for the data model only. In order to fully support the development of the Assessment Interoperability Framework (AIF), one must use SIF and IMS components to support a complete interoperability solution for assessment systems.

The IMS Global Accessible Portable Item Protocol (APIP) Standard is an interoperability standard enabling the exchange of assessment content and an examinee's accessibility needs by defining standard XML-based exchange formats. APIP also provides expectations of a computer-based assessment delivery system for the delivery of an assessment to an examinee.

The SIF Implementation Specification (US) 2.6 and SIF Data Model Implementation Specification (US): SIF3 Namespace provides interoperability standards for assessment, student information, teacher information, organizational hierarchies, learning standards and reporting.

Figure 1.1 illustrates the relationship between the two standards. The green arrows represent IMS, yellow arrows SIF and purple arrows a combination of SIF and IMS. A full explanation of the diagram can be located at <https://ceds.ed.gov/pdf/aif-definitions-and-requirements.pdf>. CEDS incorporates the data entities and elements from the SIF and IMS standards.

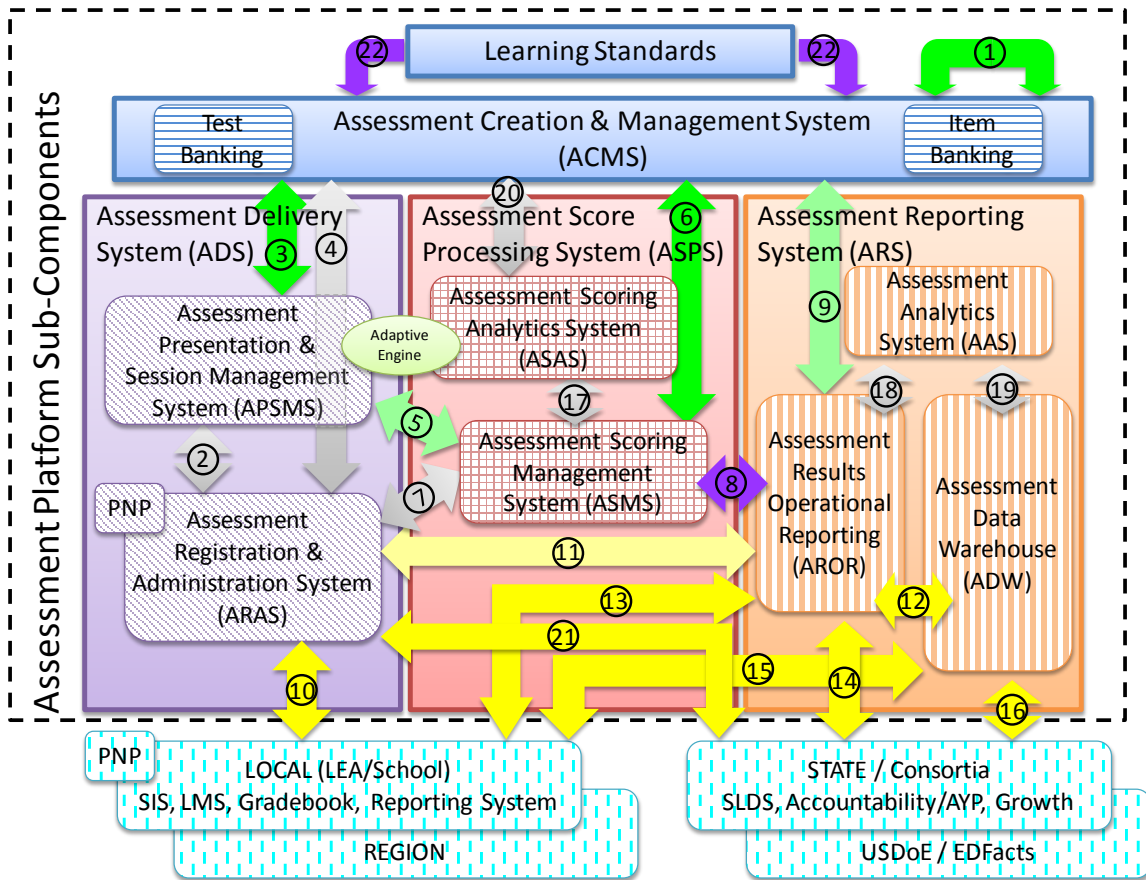

Figure 1.1: The Assessment Interoperability Framework (AIF)

1.1.1. Relationship to other Standards

With a complete implementation of CEDS and AIF, US-based or international accessibility standards are not superseded. In addition, W3C standards are used for content accessibility guidelines, HTTP(S) and XML.

IMS

AIF builds on the IMS Global APIP v1.0 standard. APIP builds on the IMS Global Question and Test Interoperability (QTI) v2.1 [QTI, 06a] and the IMS Global Access For All Personal Needs & Preferences (AfA PNP) v2.0 [AfAPNP, 10] specifications. A number of extensions have been added to both of these specifications [APIP, 12c], [APIP, 12d].

ISO

The international organization for standardization creates open, international standards for a variety of industries. ISO codes are utilized throughout CEDS for code lists.

SIF

AIF builds on the SIF Data Model Implementation Specification (US) 2.6. In addition, AIF utilizes the SIF Data Model Implementation Specification (US): SIF3 Namespace Objects for Assessment.

1.1.2. Features

IMS

The first and current version of APIP describes support for the following access features:

- Spoken
 - Text Only
 - Text and Graphics
 - Non-Visual
 - Graphics Only
 - Directions Only
 - Screen Reader Preferences
- Braille information for a refreshable Braille display, including user preferences
- References to tactile media (raised line-drawings, manipulatives)
- Sign Language
 - American Sign Language (ASL)
 - Signed English
- Translation of the entire content into a different language
- Translation of specific words, phrases, graphics, or object descriptions into a different language
- Translation of the entire content into another version of the item that uses simpler language
- Providing an alternate representation of any piece of information in the question
- Magnification, and magnification amount preferences
- Reversing the color values of the entire test
- Alternate text and background colors
- Color tint overlay over the content
- Masking certain parts of the test interface or question
- Masking of the answers when the item is first encountered
- Playing music or sounds in the background
- Allowing for additional testing time
- Allowing for breaks during the test
- Highlighting key words that need special attention
- Providing a line-by-line reading tool
- Providing extra information to language learners to clarify some information
- Providing extra information for some users who need additional cognitive guidance during testing or for something specific within an item

Ongoing work in IMS occurs to further support additional and expand upon accommodations. For example, numerous complexities with braille exist. Further development by the IMS APIP work group continues as the complexities are discussed and worked out.

SIF

The SIF Implementation Specification (US) 2.6 supports the following features as applied to the AIF:

- Providing student and teacher information and demographics
- Providing school and LEA information
- Offering learning standards taxonomies
- Creating assessment registration and administration information
- Supplying assessment results
- Delivering data warehouse data
- Transferring data warehouse and assessment results data to LEA, SEA, Consortia and regional entities as required
- Creating subtest structure
- Delivering scoring results

The current SIF Implementation Specification (US) 2.6 contains a majority of the elements of CEDS for P-12. With the release of the SIF Implementation Specification (US) 3.0 in late winter 2013, all elements of CEDS will be contained within the SIF Specification.

CEDS offers the necessary data entities and elements to support each of these features for APIP, SIF and IMS. It defines the specific elements and lists, if needed.

1.1.3. Business Case

The overarching business case for the CEDS Assessment elements includes two parts: 1) A high-level interoperability architecture for an Assessment Platform and how the Assessment Platform integrates with the broader education systems enterprise and 2) Identification of cross-standard interoperability alignments or transformations necessary for data and content to flow through the assessment platform and to other consuming or providing systems.

1.2. Structure of the Document

Constructing a Solution - An overview of how the set of examples were created and recommendations for how these can be used as best practice references.

Supporting the Use Cases - Descriptions of the specific entities and examples to show how CEDS supports the set of use cases.

1.3. References

[AfAPNP, 09] *Access For All Personal Needs & Preferences Information Model v2.0*, R.Schwerdtfeger, M.Rothberg and C.Smythe, Final Release, [IMS Global](#), April 2010.

[APIP, 12a] *Accessible Portable Item Protocol (APIP) v1.0 Overview*, Candidate Final Release, G.Driscoll, T.Hoffmann, W.Ostler, M.Russell, M.McKell and C.Smythe, [IMS Global, Inc.](#), March 2012.

- [APIP, 12b] *Accessible Portable Item Protocol (APIP) v1.0 Use Cases*, Candidate Final Release, G.Driscoll, T.Hoffmann, W.Ostler, M.Russell, M.McKell and C.Smythe, IMS Global, Inc., March 2012.
- [APIP, 12c] *Accessible Portable Item Protocol (APIP) v1.0 Technical Specification*, Candidate Final Release, G.Driscoll, T.Hoffmann, W.Ostler, M.Russell, M.McKell and C.Smythe, IMS Global, Inc., March 2012.
- [APIP, 12d] *Accessible Portable Item Protocol (APIP) v1.0 Technical Specification of QTIv2.1 Features*, Candidate Final Release, G.Driscoll, T.Hoffmann, W.Ostler, M.Russell, M.McKell and C.Smythe, IMS Global, Inc., March 2012.
- [APIP, 12e] *Accessible Portable Item Protocol (APIP) v1.0 Technical Specification of AfA PNP v2.0 Features*, Candidate Final Release, G.Driscoll, T.Hoffmann, W.Ostler, M.Russell, M.McKell and C.Smythe, IMS Global, Inc., March 2012.
- [APIP, 12f] *Accessible Portable Item Protocol (APIP) v1.0 Best Practices and Implementation Guide*, Candidate Final Release, G.Driscoll, T.Hoffmann, W.Ostler, M.Russell, M.McKell and C.Smythe, IMS Global, Inc., March 2012.
- [APIP, 12g] *Accessible Portable Item Protocol (APIP) v1.0 Conformance and Compliance*, Candidate Final Release, G.Driscoll, T.Hoffmann, W.Ostler, M.Russell, M.McKell and C.Smythe, IMS Global, Inc., March 2012.
- [APIP, 12h] *Accessible Portable Item Protocol (APIP) v1.0 Terms and Definitions*, Candidate Final Release, G.Driscoll, T.Hoffmann, W.Ostler, M.Russell, M.McKell and C.Smythe, IMS Global, Inc., March 2012.
- [CC, 11] *Common Cartridge v1.2*, Ed. J.Kahn, Final Release, IMS Global, October 2011.
- [QTI, 12a] *Question & Test Interoperability Assessment Test, Section and Item Information Model v2.1*, S.Lay, P.Gorissen and W.Kraan, Final Release, IMS Global, November 2012.
- [QTI, 12b] *Question & Test Interoperability XML Binding v2.1*, S.Lay, P.Gorissen and W.Kraan, Final Release, IMS Global, November 2012.
- [QTI, 12c] *Question & Test Interoperability Implementation Guide v2.1*, S.Lay, P.Gorissen and W.Kraan, Final Release, IMS Global, November 2012.
- [QTI, 12d] *Question & Test Interoperability Metadata and Usage Data v2.1*, S.Lay, P.Gorissen and W.Kraan, Final Release, IMS Global, November 2012.

2. Constructing a Solution

Creating a comprehensive solution for an entire assessment system and AIF requires many systems to work together and use open standards. The following offer a representation of some of the system and intricacies for consideration:

- Delivery of accessible content to a student
- Delivery system provides what the user needs and the test/item content.
- Reporting system supplying data in various formats both for ad hoc and template reporting
- Data warehouse or student information system providing the necessary information to the registration system
- Scoring system scoring student results and providing results to the reporting system

These few examples offer a glimpse into the complexities involved. This section details each of the systems and how to apply best practices for consistency in implementation of the standards for interoperability.

IMS, APIP, and SIF Implementation Specifications	Link
IMS Global APIP Best Practices and Implementation Guide [APIP, 12f]	http://imglobal.org/apip/apipv1p0cf/APIPv1p0_Best_v1p0cf.html
IMS Global APIP Technical Specification v1.0 [APIP, 12e]	http://www.imglobal.org/apip/apipv1p0cf/APIPv1p0_Profile_v1p0cf.html
SIF Data Model Implementation Specification (US): SIF3 Namespace	http://specification.sifassociation.org/Implementation/US/2.6/html/AssessmentSif3Namespace.html#AssessmentSif3Namespace
SIF Implementation Specification (US) 2.6	http://specification.sifassociation.org/Implementation/US/2.6/html

2.1. Learning Standards

Learning standards form the foundation for measuring the knowledge a student has in an assessment. With the assessment consortia, the CCSS make up the learning standards. Additional standards will also be supported (for example, state science or social studies standards). To obtain interoperability, a common data structure for learning standards is essential.

2.1.1. Learning Standard Annotation in APIP

APIP supports an extensive range of metadata including the use of the IMS Curriculum Standards Metadata (CSM) v1.0 specification (defined as part of the IMS Common Cartridge v1.2 specification [CC, 11]) that is used to annotate the resources with the corresponding learning standards references.

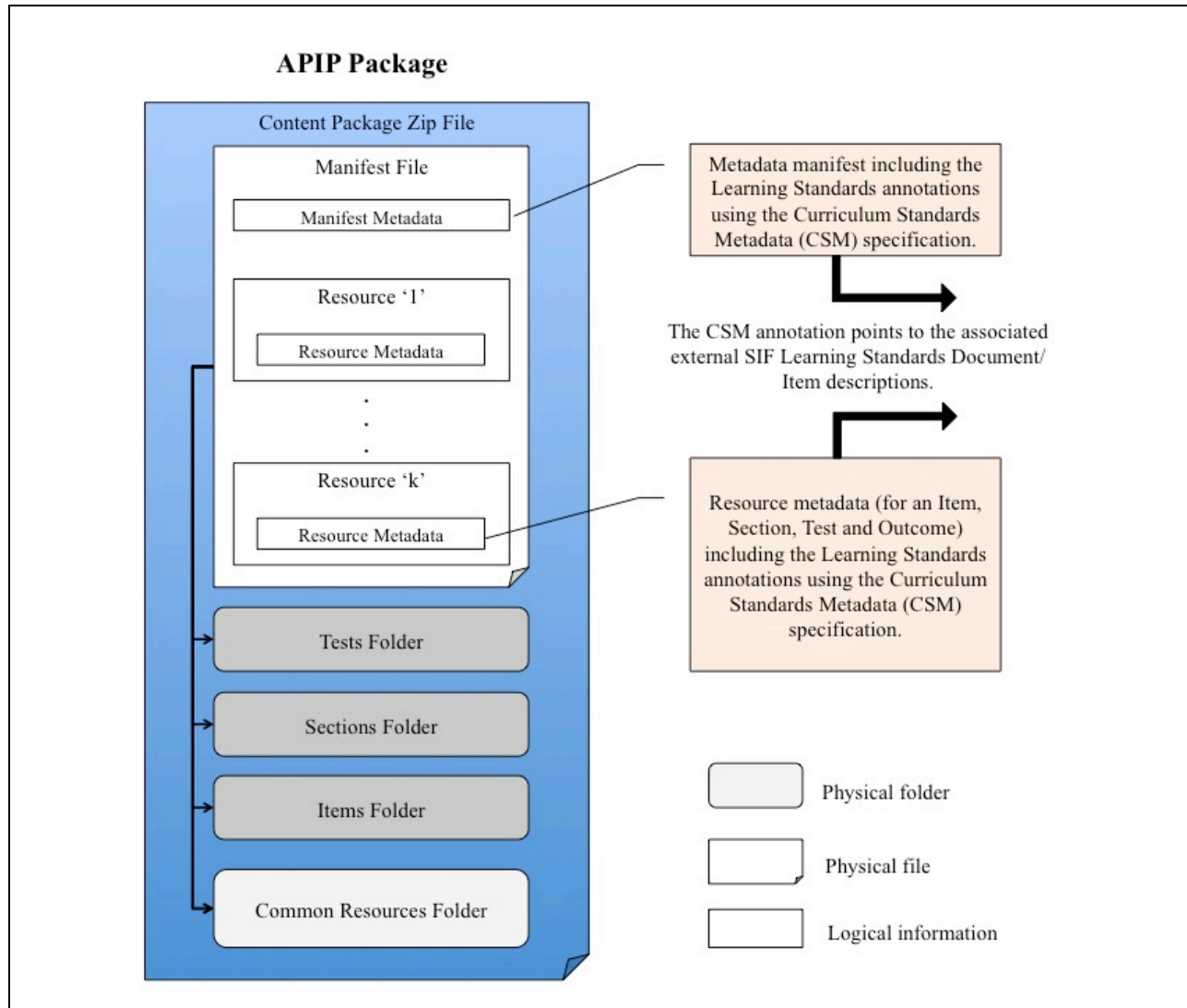

Figure 2.1 APIP support for learning standards annotation of assessment constructs

The use of the CSM in APIP is shown schematically in Figure 2.1. The CSM in APIP consists of a GUID that is used to point to an external learning standards definition system i.e. the learning standards definitions are not contained within the APIP Package. For the AIF, the CSM can be used to point to the external SIF Learning Standards Document/Item definitions. The SIF elements are then used to contain the learning standards themselves. It is the responsibility of the importing and exporting systems to provide the reconciliation mappings between the SIF GUID and the Learning Standards Document/Item objects and the actual learning standards. An example of the use of the CSM annotation of a resource is shown in the following code listing.

001	<resource identifier="RES001" type="imsqti_apiptest_xmlv2p1">
002	<metadata>
003	<curriculumStandardsMetadataSet xmlns=http://...
004	<curriculumStandardsMetadata providerId="SIF">
005	<setOfGUIDs>
006	<labelledGUID>
007	<label>...human readable comment...</label>
008	<GUID>... SIF LS GUID...</GUID>
009	</labelledGUID>
010	<labelledGUID>
011	<label>...human readable comment...</label>
012	<GUID>...SIF LS GUID...</GUID>
013	</labelledGUID>
014	</setOfGUIDs>
015	</curriculumStandardsMetadata>
016	</curriculumStandardsMetadataSet>
017	</metadata>
018	...
019	</resource>

The key points in the CSM code listing are:

- a) The type of APIP resource is identified by the 'type' attribute for the 'resource' element (see line 001). In this example the annotation is for an APIP Test;
- b) The use of SIF as the reference system is denoted by the use of the 'providerId' attribute on the 'curriculumStandardsMetadata' element (see line 004);
- c) The various learning standards annotations, only two are used in this example, are then denoted using the appropriate SIF GUIDs (see lines 008 and 012);
- d) It is recommended that human readable labels be supplied to give a clue as to the nature of the learning standard annotation (see lines 007 and 013).

It should be noted that APIP allows more than one annotation scheme to be applied to the assessment objects. Other annotation approaches would have a separate 'curriculumStandardsMetadata' element.

If necessary, the learning standards definitions can be contained within the APIP Package. Each learning standard document/item must be contained within its own XML instance file. For each such instance file, there must be a 'resource' defined within the APIP Package file (this will require a new resource type to be added to the current set of allowed APIP resource types) and the dependencies to the actual assessment resources should also be defined.

The SIF Association and IMS Global are following the ongoing work occurring for the more granular identifiers and metadata for the Common Core State Standards with PARCC, Smarter Balanced, CCSSO and SETDA. Once this work has completed, modifications will be made to the standards for AIF to support this.

2.2. Authoring Content and Item Banking

Authoring content and supplying this content to the item banking system necessitates numerous components. The content must include accommodation information and be conformant to the APIP standard. Design considerations include:

- Item Content Package Information
- Test Sections
- Item Variants
- Parts of the Item Content
- Connecting Content to Access Elements
- Access Features for the Delivery System
- Inclusion Orders
- Multiple Access Elements for the Same Content
- Companion Materials

2.2.1. Authoring Recommendations

Some key principles to adopt when creating the Item and controlling the presentation form are:

- a) Use Cascading Stylesheets (CSS) to maintain the separation of the presentation from the XML structures. Avoid using the presentation structures in HTML and instead use the 'class' attribute with defined CSS attributes;
- b) Establish the set of CSSs that will be used to control the layout of an Item and each of the component interactions, the available feedback and the associated rubric blocks. Define Section level CSSs and take into account that some rubric block level information will be used as common content for two or more Items;
- c) Always assign a unique identifier value (using the 'id' attribute for the HTML elements) to every HTML element. This ensures that APIP accessibility structures can always be assigned as alternative formats to the equivalent QTI XHTML;
- d) Agree the range of Outcome variables that will be defined for each Item. These must be sufficient to reflect the full range of outcomes that will eventually be reported by an Assessment System;
- e) Create a set of response processing templates to support the various Item/Interaction combinations that will be created by the content authors (each interaction should have a common layout definition). This will simplify the range of possible response processing approaches required within a Scoring System. The associated Response variables should be matched to the Outcomes variables to ensure consistent Item characterization;
- f) The range of alternative accessibility content for each of the types of Items/Interactions should be defined as part of the content authoring guidelines. Not all Item/Interaction-types are suited to certain types of accessibility;
- g) If rubric (Section and Item level) and feedback content is to be presented to the learner undergoing assessment, then the equivalent alternative accessibility representations must also be defined;
- h) APIP supports a wide range of metadata (including learning standard annotation). It is essential that the required set of metadata fields be agreed for each

Item/Interaction-type, package resource and manifest. Provision through computer generation is preferred to relying upon human provision;

- i) All QTI identifiers assigned to the Items should be 32 character GUIDs as per the SIF GUID format. This ensures that all the QTI identifiers can then be referenced as SIF GUIDs without recourse to an intermediate mapping.

2.2.2. Item Bank/Assessment System APIP Interoperability Architecture

Interoperability between an Authoring System and an Item Bank is addressed by the use of the IMS APIP v1.0 specification [APIP, 12c]. The corresponding interoperability architecture is shown in Figure 2.2.

APIP Packages (a form of zip file) are the interoperability objects. These are used for two types of Item Bank based exchange:

- Item Bank to/from Item Bank – item banks can exchange items using APIP. An item bank would either import or export the APIP Package (a single package could contain all of the Items and the associated assets);
- Item Bank to/from Authoring System – an authoring system will acquire the content by importing an APIP Package. When content is to be stored then it will be exported from the authoring system into the item bank.

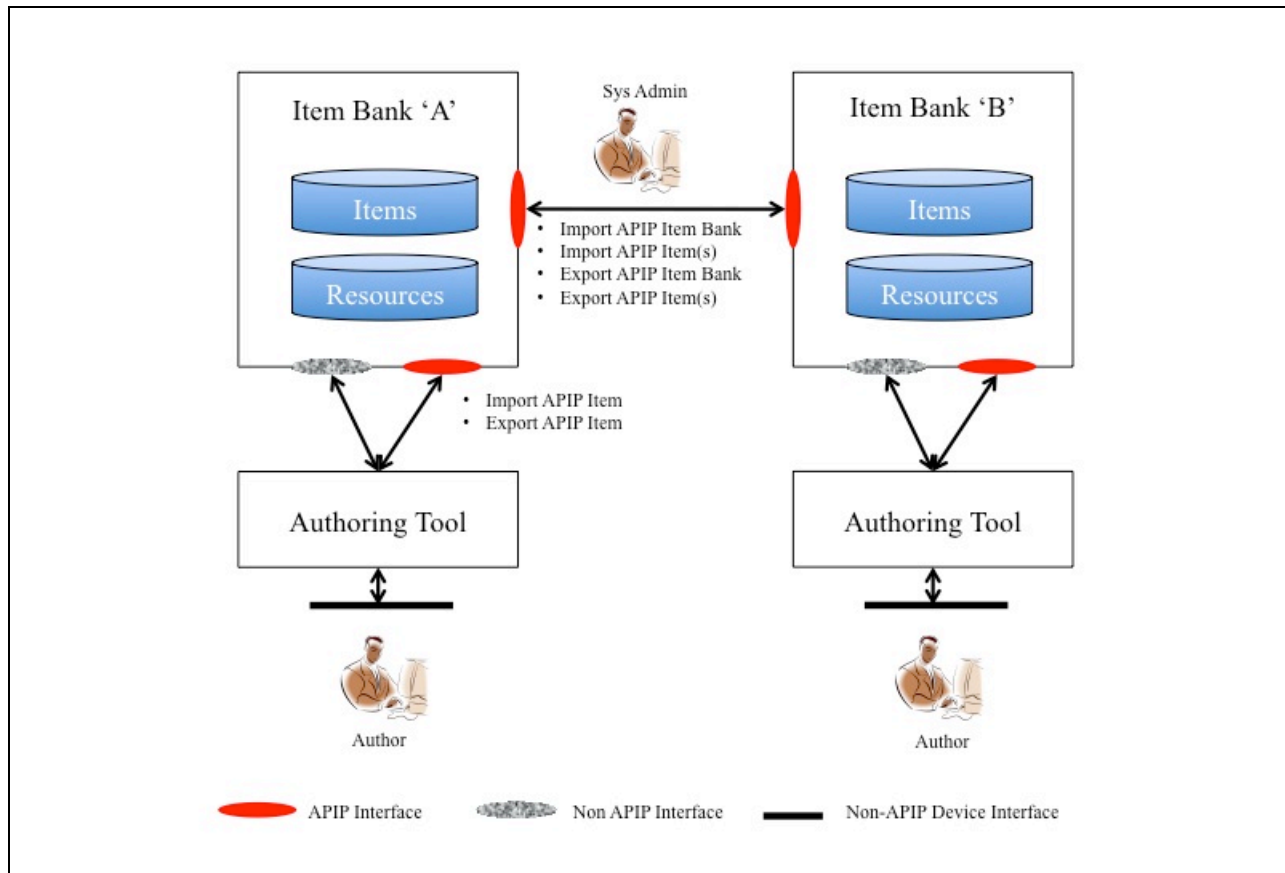

Figure 2.2 APIP authoring and item banking interoperability architecture

Manual construction of an APIP Package (including the associated manifest file) is beyond the capabilities of all but the most expert of XML coders. The APIP Packages MUST be created by the corresponding system (any APIP Package can be validated against the online IMS APIP Validator – <http://validator.imsglobal.org/apip>).

2.2.3. Item Bank APIP APIs

It is not expected that the internal format within an Item Bank and/or Authoring System is native APIP. The format of the APIP Package must be as defined in the APIPv1.0 specification. APIP does NOT define how the package is to be exchanged between systems. Therefore it is recommended that three APIs be defined, as identified in Figure 2.3, as part of any architectural definition involving APIP. The core three APIs are:

- [A] Item Bank to Item Bank exchange – to enable the Item Banks to exchange APIP Packages including the entire Item Bank itself;
- [B] Item Bank to Authoring System storage – storage and retrieval to/from an Item Bank of the Item(s) and/or Section(s) being authored
- [C] Item Bank based interactive editing – remote editing of an Item and/or Section. In this situation the interface allows the components of an APIP Package to be accessed/modified as and when required. For example, items could be added to a Section, the rubric for an Item could be changed, etc.

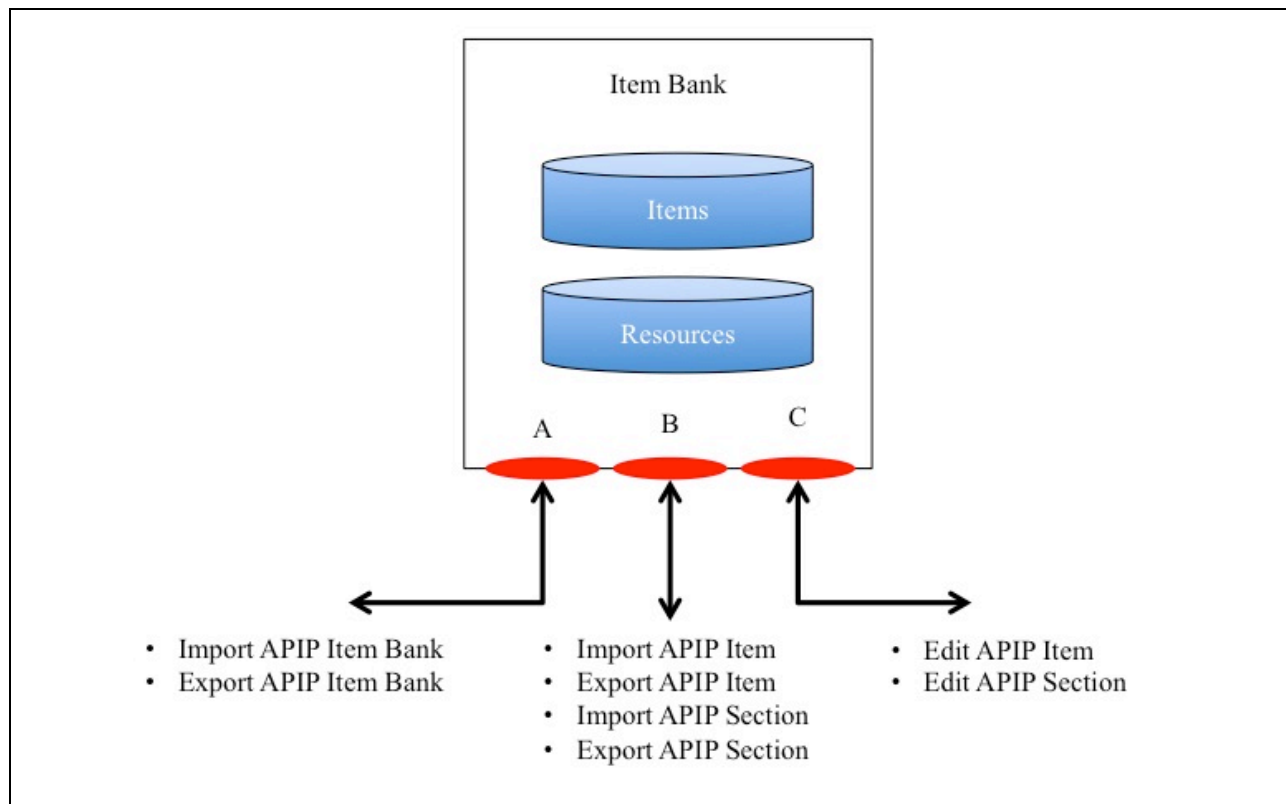

Figure 2.3 Suggested APIP item bank APIs

These three APIs can be supported by several transport mechanisms. It is recommended that:

- Item Bank to Item Bank should use a SOAP-based web service with a corresponding security capability. The APIP Package should NOT be passed in the SOAP message;
- Item Bank to Authoring System storage could use either a SOAP or REST based approach. The nature of the authoring system should guide the preferred approach;
- Item Bank based interactive editing should use a REST/XML or REST/JSON web service. Only partial APIP XML structures are to be exchanged.

2.3. Test Banking

Test banks provide all the management functions for creating, editing, and publishing forms of tests that can be delivered to students. Test banks define all scoring information in order to derive total test and strand/sub-test scores including raw, scale, percents, norms, performance levels, etc. as well as which learning standards scores report against.

2.3.1. Authoring Recommendations

Some key principles to adopt when creating a Test and controlling the presentation form are:

- a) Agree the basis under which more than one TestPart is to be created for a Test;
- b) Agree the range of Outcome variables that will be defined for each Test. These must be sufficient to reflect the full range of outcomes that will eventually be reported by an Assessment System;
- c) Establish the CSSs that will be used to control the layout of the test feedback and agree the range of alternative accessibility content;
- d) Define the conditions under which the Test-level and TestPart-level feedback content is required;
- e) All QTI identifiers assigned to the Tests, TestParts and Sections should be 32 character GUIDs as per the SIF GUID format. This ensures that all the QTI identifiers can then be referenced as SIF GUIDs without recourse to an intermediate mapping;
- f) Each Section should be contained in its own XML instance. The set of TestParts are contained in same instance file as the Test itself;
- g) APIP supports a wide range of metadata (including learning standard annotation). It is essential that the required set of metadata fields be agreed for each Test, package resource and manifest. Provision through computer generation is preferred to relying upon human provision.

2.3.2. Test Bank APIP Interoperability Architecture

Interoperability between an Authoring System and a Test Bank is addressed by the use of the IMS APIP v1.0 specification [APIP, 12c]. The corresponding interoperability architecture is shown in Figure 2.4.

APIP Packages (a form of zip file) are the interoperability objects. These are used for two types of Item Bank based exchange:

- Test Bank to/from Test Bank – test banks can exchange tests (including all of the associated items, sections and assets) using APIP. A test bank would either import or export the APIP Package (a single package could contain all of the Items and the associated assets);
- Test Bank to/from Authoring System – an authoring system will acquire the content by importing an APIP Package. When content is to be stored it will then be exported from the authoring system into the test bank.

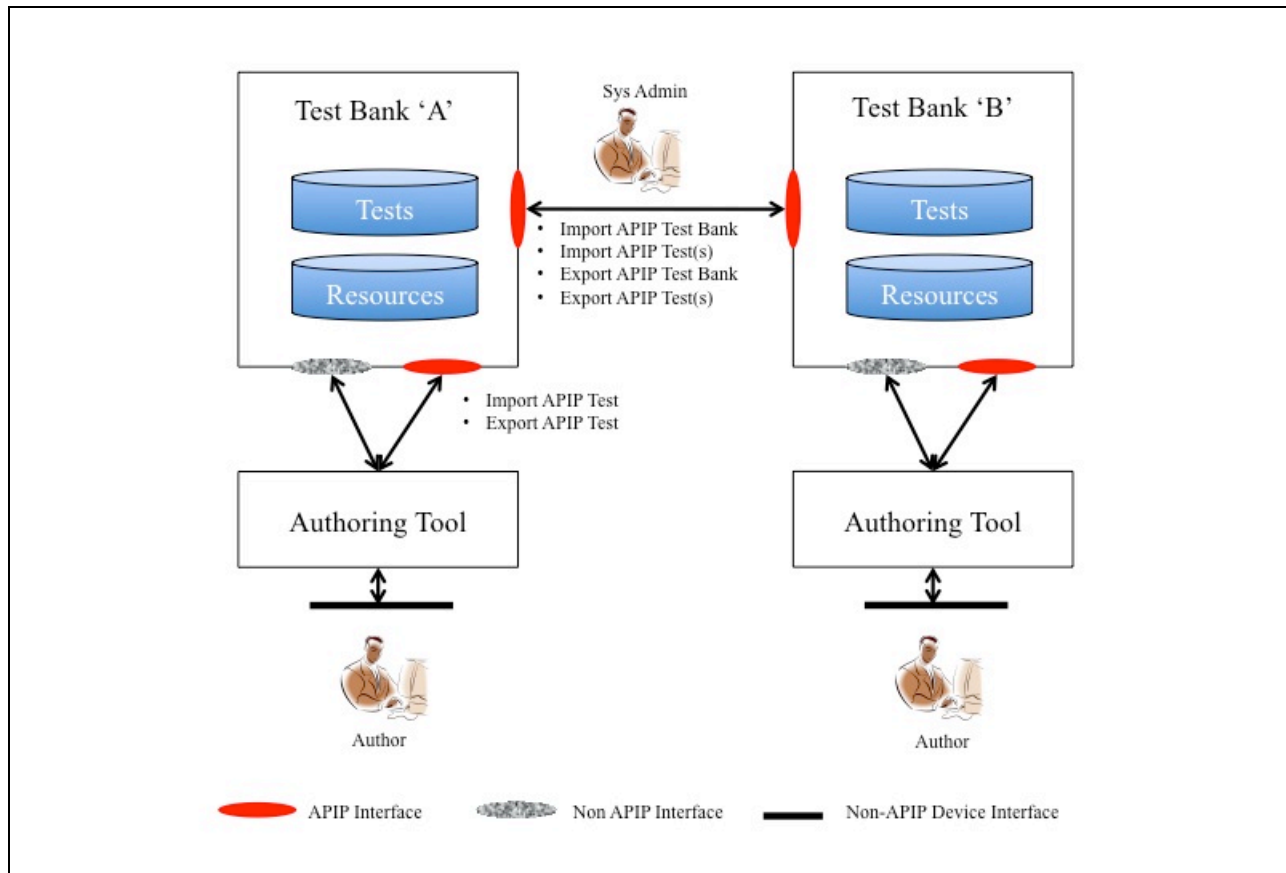

Figure 2.4 APIP authoring and test banking interoperability architecture

As for the Item Bank, manual construction of an APIP Package (including the associated manifest file) is beyond the capabilities of all but the most expert of XML coders. The APIP Packages MUST be created by the corresponding system (any APIP Package can be validated against the online IMS APIP Validator – <http://validator.imsglobal.org/apip>).

2.3.3. Test Bank APIP APIs

Once again, it is not expected that the internal format within a Test Bank is native APIP. Therefore it is recommended that four APIs be defined, as identified in Figure 2.5, as part of any architectural definition involving APIP.

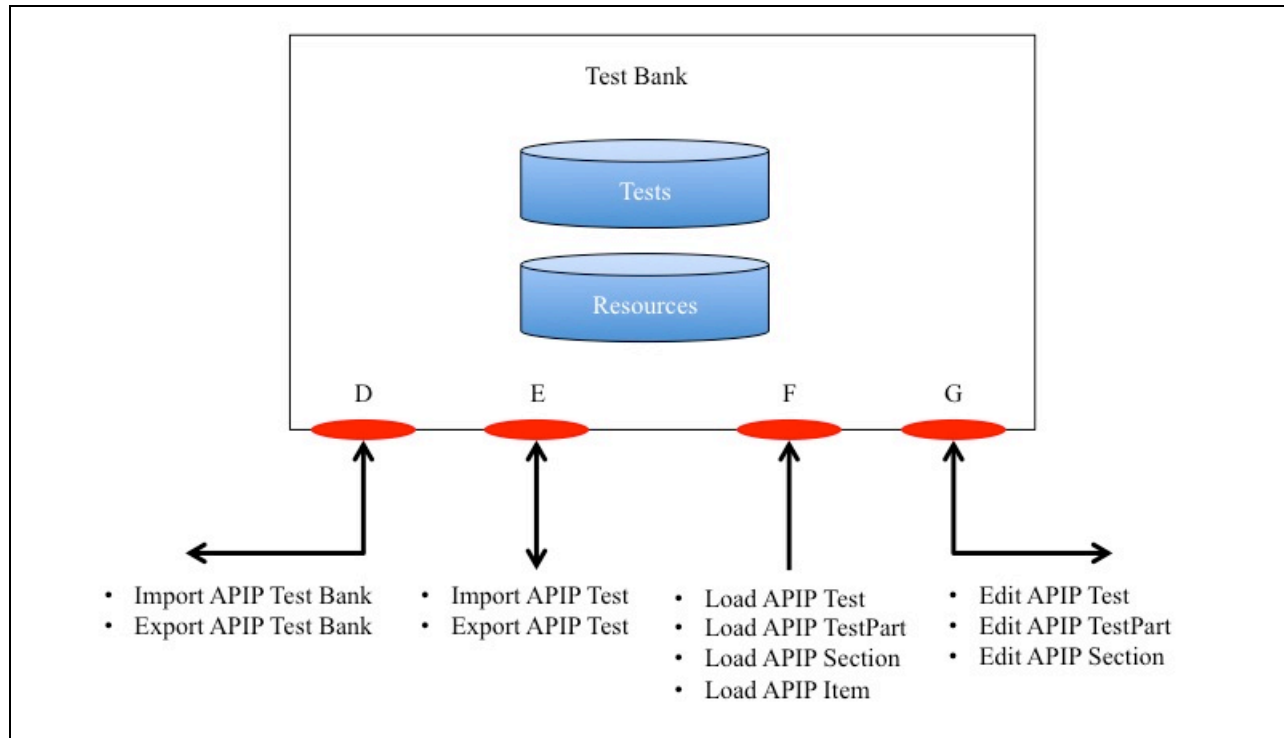

Figure 2.5 Suggested APIP test bank APIs

The four core APIs are:

- [D] Test Bank to Test Bank exchange – to enable the Test Banks to exchange APIP Packages including the entire Test Bank itself;
- [E] Test Bank to Authoring System storage – storage and retrieval to/from a Test Bank of the Test(s) with the associated Items and Sections also passed in the APIP Package;
- [F] Test Bank to Assessment Delivery System – this interface should pass only the core object instance information (other operations should be defined to load any associated assets e.g. sound file, etc.). This allows the Assessment Delivery System to load each core object as required i.e. only a subset of the full set of Sections/Items may be required by an actual Test instance;
- [G] Test Bank based interactive editing – remote editing of a Test, TestPart and Section. In this situation the interface allows the components of an APIP Package to be accessed/modified as and when required. For example, sections could be added to a Test, the feedback for a Test could be changed, etc.

It is recommended that the transport technologies to be considered for these APIs are:

- Test Bank to Test Bank should use a SOAP-based web service with a corresponding security capability. The APIP Package should NOT be passed in the SOAP message;
- Test Bank to Authoring System storage could use either a SOAP- or REST-based approach. The nature of the authoring system should guide the preferred approach;

- Test Bank to Assessment Delivery System could use either a SOAP- or REST-based approach. The nature of the assessment delivery system should guide the preferred approach;
- Test Bank based interactive editing should use a REST/XML or REST/JSON web service. Only partial APIP XML structures are to be exchanged.

2.3.4. Authoring System APIP APIs

An authoring system may support creation/changing of Tests, TestParts, Sections and Items. Therefore it is recommended that four APIs be defined, as identified in Figure 2.6, as part of any architectural definition involving APIP.

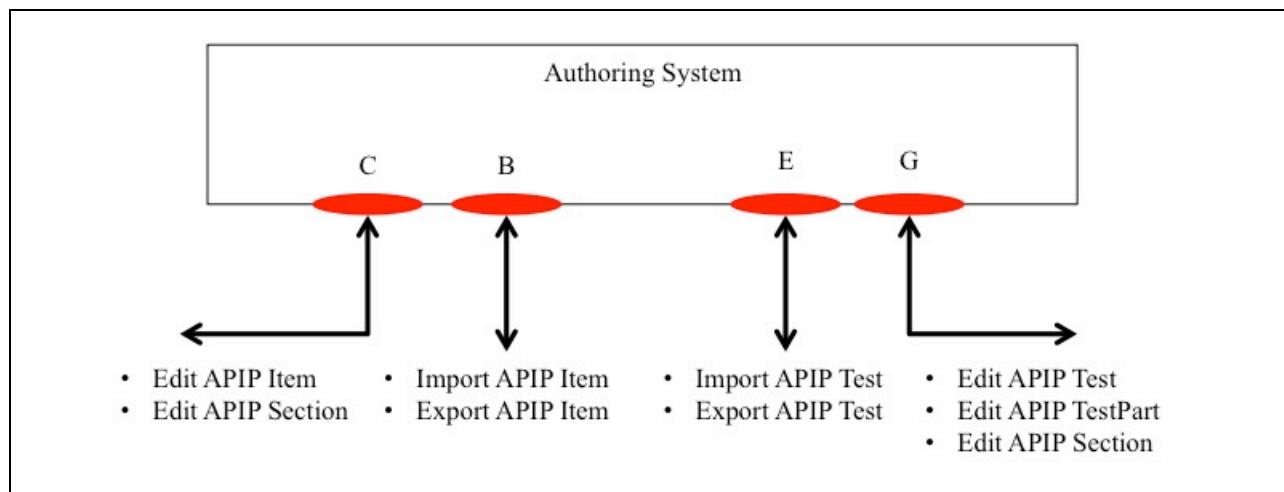

Figure 2.6 Suggested APIP authoring system APIs

The four core APIs are:

- [B] Authoring System to Item Bank storage – storage and retrieval to/from an Item Bank of the Item(s) and/or Section(s) being authored;
- [C] Item Bank based interactive editing – remote editing of an Item and/or Section. In this situation the interface allows the components of an APIP Package to be accessed/modified as and when required. For example, items could be added to a Section, the rubric for an Item could be changed, etc.
- [E] Authoring System to Test Bank storage – storage and retrieval to/from a Test Bank of the Test(s) with the associated Items and Sections also passed in the APIP Package;
- [G] Test Bank based interactive editing – remote editing of a Test, Test Part and Section. The interface allows the components of an APIP Package to be accessed/modified as and when required. For example, sections could be added to a Test, the feedback for a Test could be changed, etc.

See the corresponding sub-sections for the recommendations of how each of the above APIs should be realized in terms of service transport.

2.4. Assessment Presentation and Session Management System

The assessment presentation and session management system delivers the actual assessment. All delivery considerations are taken into account here, including the merging of the assessment registration information, delivery, scoring and accommodations.

2.4.1. Assessment Delivery System APIP Interoperability Architecture

APIP does not require the contained markup to be the run-time delivery format. There are several reasons but the most important is that a significant amount of preprocessing may be required to convert the content into the format that is best suited to the accessibility needs of the learner. It may be impractical to achieve this preprocessing in real-time when hundreds or thousands of concurrent tests may be active. The delivery architecture assumed by APIP is shown in Figure 2.7.

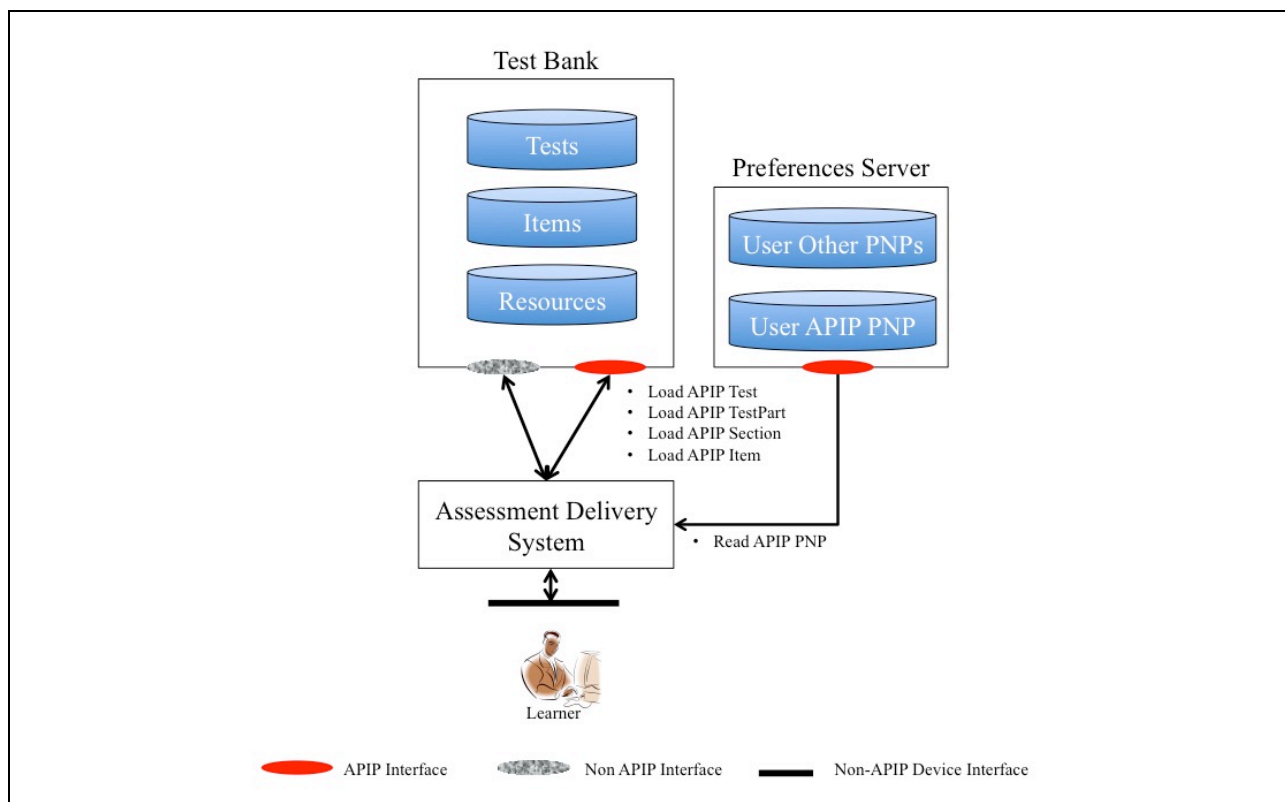

Figure 2.7 Assessment delivery system APIP interoperability architecture

There are two core APIP interfaces to a delivery system:

- Loading of the appropriate APIP Packages to allow the delivery system to pre-construct the test in terms of the content that matches the Personal Needs & Preferences (PNP) of each learner i.e. the form of the test instance is tailored to the individual learner. Further pre-construction involves rendering of the content in the presentation format native to the delivery system's learner interface (this could be in the form of HTML5, Flash, etc.). Once constructed this test instance is stored in the Test Bank in the format ready for real-time delivery when the learner 'sits' the test. Each load instruction should be designed to pass an APIP Package that contains the single XML instance file and the associated child assets. For example,

the loading of a test will be followed by the loading of the first and subsequent Sections/assets, that will in turn require the loading of the first and subsequent Items/assets;

- Reading of the APIP PNP files for the set of learners that will undertake the specific test. The APIP PNP will, in general, be a subset of the PNP settings for a learner i.e. only the information relevant for online assessment is required. The APIP PNP includes a subset of the broader IMS Access for All PNP v2.0 specification and so a wider range of information, if required, can be supplied using the same instance file.

2.4.2. Preferences Server APIP APIs

The Preferences Server is responsible for containing all of the roles and personalization configuration information for a learner, including those required for online assessment. Therefore it is recommended that two APIs be defined, as identified in Figure 2.8, as part of any architectural definition involving APIP.

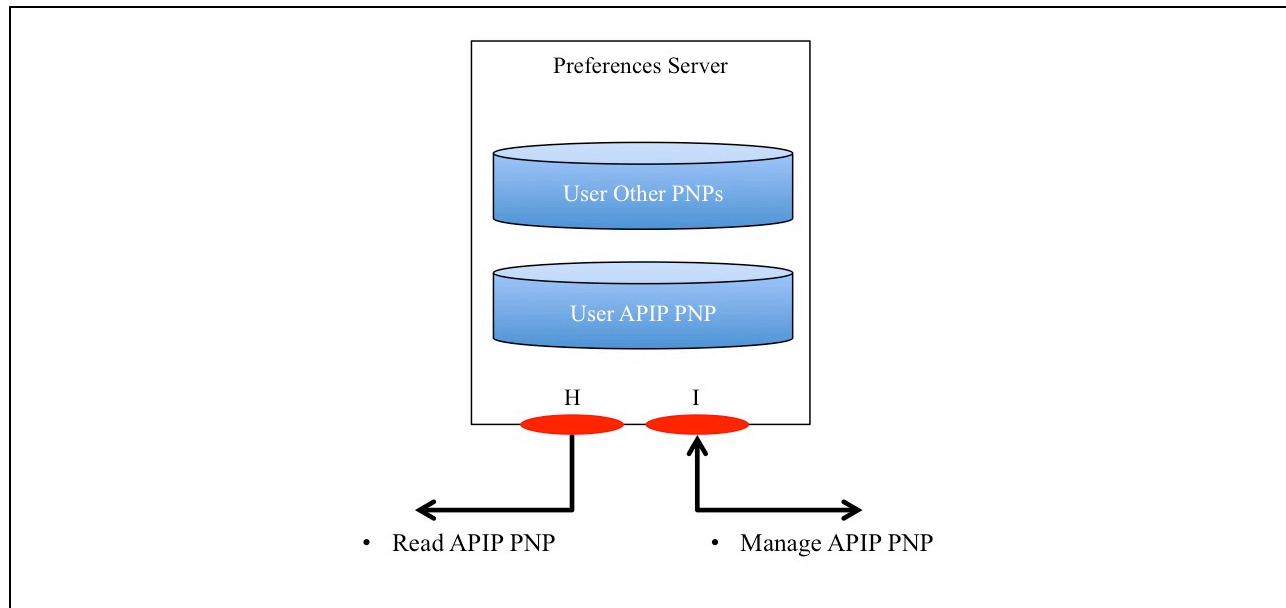

Figure 2.8 Suggested APIP preferences server APIs

The two core APIs are:

- [H] Preferences Server to Assessment Delivery System – provision of an APIP PNP instance file. It is recommended that this is a secure link using either a SOAP or REST approach;
- [I] Preferences Server to Management User Interface – the external interface that is used to enable a user to enter and manage their PNP settings. This will normally take the form of a secure web interface i.e. access via a web browser using HTTPS.

2.4.3. Assessment Delivery System APIP APIs

The Assessment Delivery System is responsible for all of the preparation and delivery of the test for each learner registered for the test. Therefore it is recommended that two APIs be defined, as identified in Figure 2.9, as part of any architectural definition involving APIP.

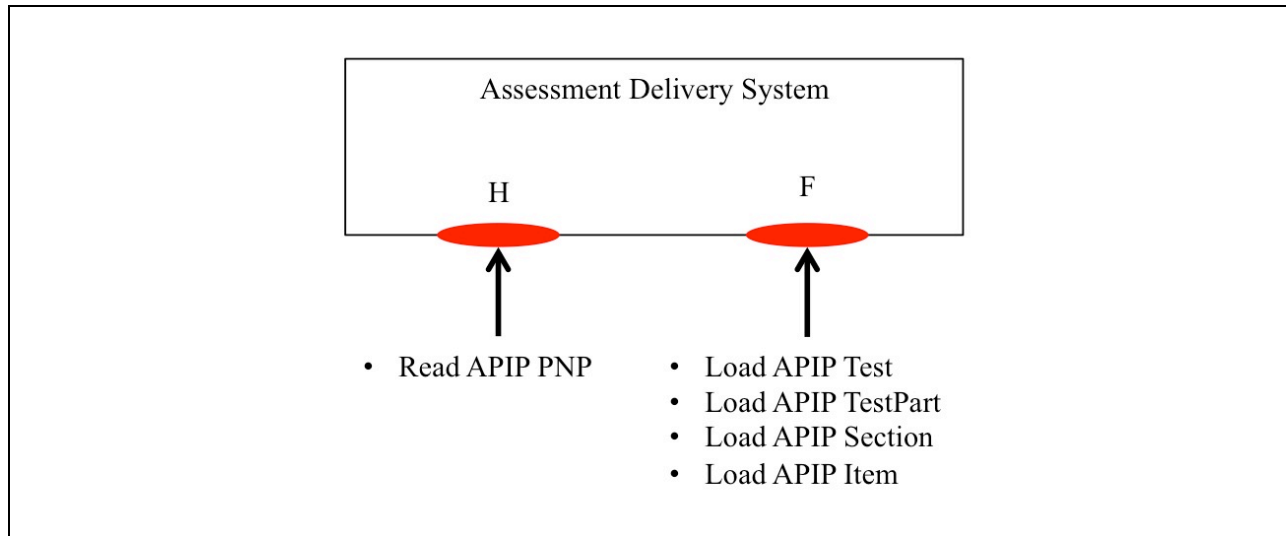

Figure 2.9 Suggested APIP assessment delivery system APIs

The two core APIs are:

- [F] Test Bank to Assessment Delivery System – this interface should pass only the core object instance information (other operations should be defined to load any associated assets e.g. sound file, etc.). This allows the Assessment Delivery System to load each core object as required i.e. only a subset of the full set of Sections/Items may be required by an actual Test instance. This API could use either SOAP or REST based approaches. The nature of the assessment delivery system should guide the preferred approach;
- [H] Preferences Server to Assessment Delivery System – provision of an APIP PNP instance file. It is recommended that this is a secure link using either SOAP/REST approaches.

2.5. Assessment Registration and Administration System

Often assessment registration and administration systems (ARASs) include in the assessment presentation and session management system. The assessment registration system gathers student, teacher and hierarchy information from the data warehouse or student information system, generating the actual registration for an assessment. In addition, the PNP information about the student enters in at this time.

2.5.1. PNP Provision for the ARAS

In many cases, the PNP information is provided by a Preferences Server (as shown in Figure 2.10). This approach allows many systems to easily access the range of PNP settings for users.

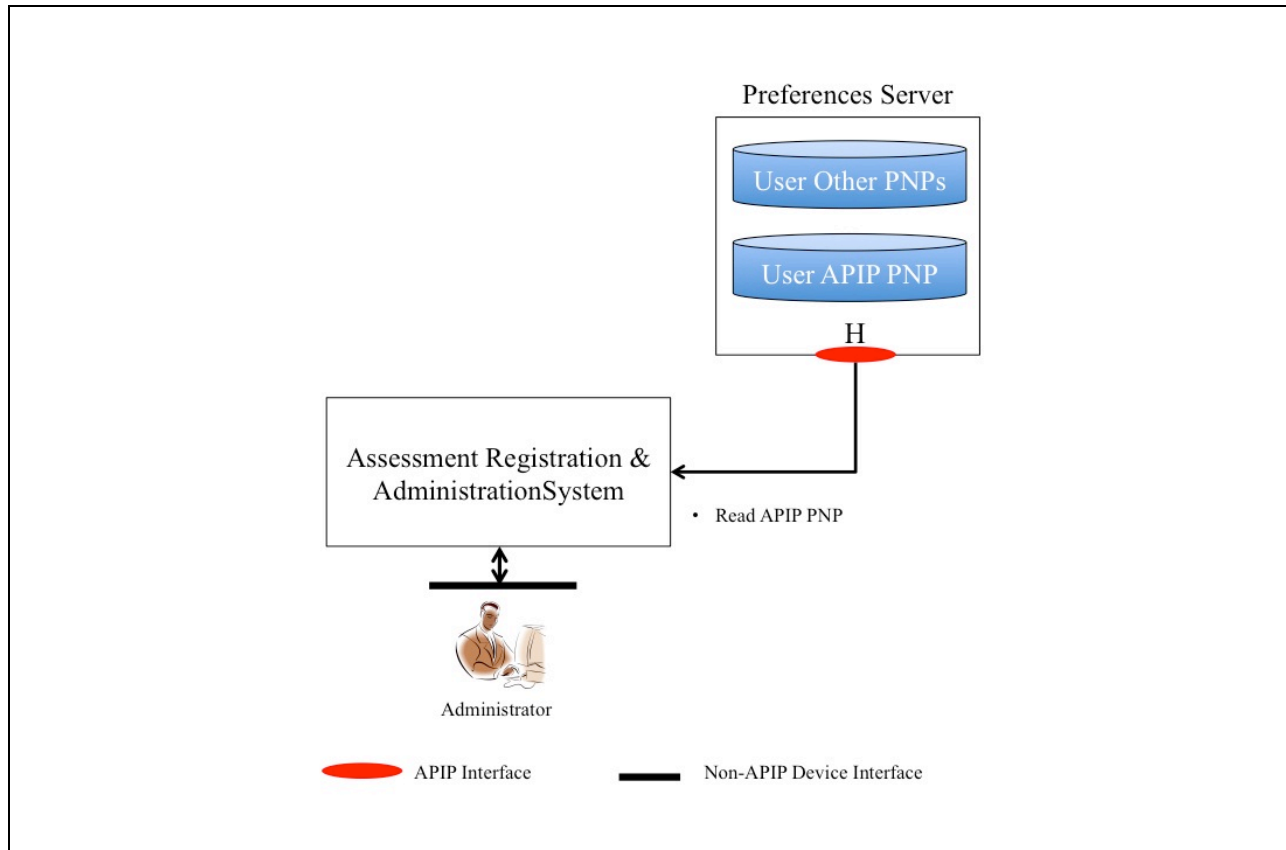
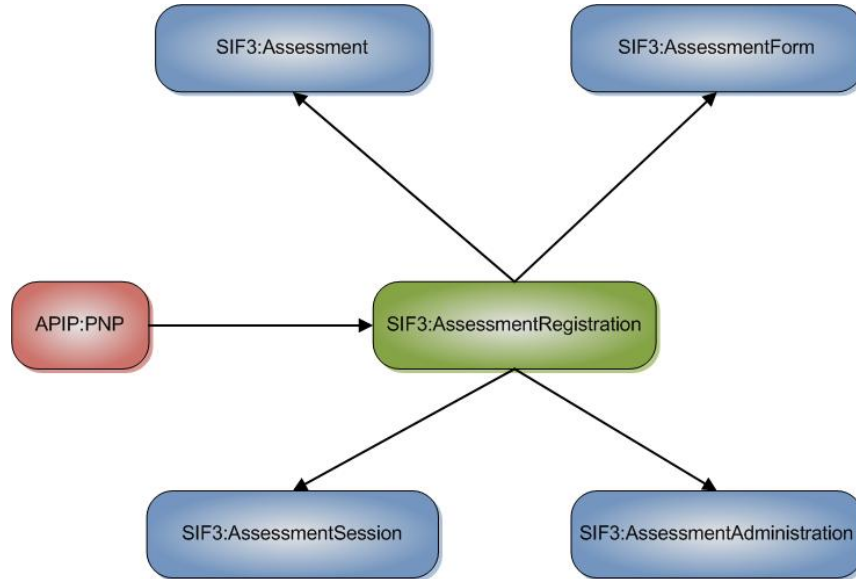

Figure 2.10 PNP provision to the assessment administration & registration system

From the perspective of supplying the PNP, the API [H] is used to provide the APIP PNP instance file. It is recommended that this is a secure link using either a SOAP or REST approach. The PNP is defined as an XML structure and so it can also be passed, as an extension data structure, within a SIF messaging system (these are sensitive and private data and must be encrypted when passed across a loosely coupled infrastructure). A user may have several PNPs, for a variety of different learning situations, and so it is the responsibility of the ARAS to obtain the correct PNP version.

Assessment registration and administration systems often include in the assessment presentation and session management system. The assessment registration system gathers student, teacher and hierarchy information from the data warehouse or student information system, generating the actual registration for an assessment. In addition, the PNP information about the student enters in at this time.

2.5.2. SIF Provision for ARAS



Data Flow

- Assessments and Assessment Forms are created.
- An assessment administration is planned. The Assessment Administration is created.
- Students are registered to take an assessment. The Assessment Registration is created along with the PNP.
- Students are assigned to take the assessment at a particular time and place. The Assessment Session is created.
- After the student takes the assessment, the Assessment Registration or Assessment Session may be updated with information from the assessment event.

2.5.3. PNP XML Example

An example of the APIP PNP XML is shown in the code set listed below. The APIP consists of extensions to the original IMS Global AfA PNP v2.0 specification [AfAPNP, 09]. The APIP extensions are denoted by the shaded lines in the code example.

```

001 <accessForAllUser
002   xmlns="http://www.imsglobal.org/xsd/apip/apipv1p0/imsafa_pnpv2p0"
003   xmlns:apip="http://www.imsglobal.org/xsd/apip/apipv1p0/imsapip_pnpv1p0"
004   xmlns:xsi="http://www.w3.org/2001/XMLSchema-instance"
005   xsi:schemaLocation="...">
006   <content>
007     <apip:apipContent>
008       <apip:spoken>
  
```

```

009     <apip:assignedSupport>true</apip:assignedSupport>
010     <apip:activateByDefault>true</apip:activateByDefault>
011     <apip:spokenSourcePreference>Human</apip:spokenSourcePreference>
012     <apip:readAtStartPreference>true</apip:readAtStartPreference>
013     <apip:userSpokenPreference>TextOnly</apip:userSpokenPreference>
014     <apip:directionsOnly>false</apip:directionsOnly>
015   </apip:spoken>
016   <apip:signing>
017     <apip:assignedSupport>true</apip:assignedSupport>
018     <apip:activateByDefault>true</apip:activateByDefault>
019     <apip:signingType>ASL</apip:signingType>
020   </apip:signing>
021   <apip:itemTranslationDisplay xml:lang='en'>
022     <apip:assignedSupport>true</apip:assignedSupport>
023     <apip:activateByDefault>true</apip:activateByDefault>
024   </apip:itemTranslationDisplay>
025   <apip:keywordTranslations xml:lang='es'>
026     <apip:assignedSupport>true</apip:assignedSupport>
027     <apip:activateByDefault>false</apip:activateByDefault>
028   </apip:keywordTranslations>
029   <apip:simplifiedLanguage>
030     <apip:assignedSupport>true</apip:assignedSupport>
031     <apip:activateByDefault>true</apip:activateByDefault>
032   </apip:simplifiedLanguage>
033   <apip:alternativeRepresentations>
034     <apip:assignedSupport>true</apip:assignedSupport>
035     <apip:activateByDefault>false</apip:activateByDefault>
036     <apip:alternativeRepresentationType>Text
037   </apip:alternativeRepresentationType>
038   </apip:alternativeRepresentations>
039   <apip:cognitiveGuidance>
040     <apip:assignedSupport>true</apip:assignedSupport>
041     <apip:activateByDefault>false</apip:activateByDefault>
042   </apip:cognitiveGuidance>
043   <apip:languageLearner>
044     <apip:assignedSupport>true</apip:assignedSupport>
045     <apip:activateByDefault>false</apip:activateByDefault>
046   </apip:languageLearner>
047   <apip:keywordEmphasis>
048     <apip:assignedSupport>true</apip:assignedSupport>
049     <apip:activateByDefault>false</apip:activateByDefault>
050   </apip:keywordEmphasis>
051 </apip:apipContent>
052 </content>
053 <control>
054   <apip:apipControl>
055     <apip:additionalTestingTime>
056       <apip:assignedSupport>true</apip:assignedSupport>
057       <apip:timeMultiplier>1.5</apip:timeMultiplier>
058     </apip:additionalTestingTime>
059     <apip:breaks>
060       <apip:assignedSupport>true</apip:assignedSupport>
061     </apip:breaks>
062     <apip:lineReader>
063       <apip:assignedSupport>true</apip:assignedSupport>

```

064	<apip:activateByDefault>>false</apip:activateByDefault>
065	<apip:colour>99FFCC</apip:colour>
066	</apip:lineReader>
067	</apip:apipControl>
068	</control>
069	<display>
070	<braille>
071	<apip:assignedSupport>>true</apip:assignedSupport>
072	<apip:activateByDefault>>true</apip:activateByDefault>
073	<brailleGrade>contracted</brailleGrade>
074	<numberOfBrailleDots>8</numberOfBrailleDots>
075	<brailleDotPressure>0.7</brailleDotPressure>
076	</braille>
077	<tactile>
078	<apip:assignedSupport>>true</apip:assignedSupport>
079	<apip:activateByDefault>>true</apip:activateByDefault>
080	</tactile>
081	<apip:apipDisplay>
082	<apip:masking>
083	<apip:assignedSupport>>true</apip:assignedSupport>
084	<apip:activateByDefault>>false</apip:activateByDefault>
085	<apip:maskingType>AnswerMask</apip:maskingType>
086	</apip:masking>
087	<apip:auditoryBackground>
088	<apip:assignedSupport>>true</apip:assignedSupport>
089	<apip:activateByDefault>>false</apip:activateByDefault>
090	</apip:auditoryBackground>
091	</apip:apipDisplay>
092	<screenEnhancement>
093	<magnification>3</magnification>
094	<apip:apipScreenEnhancement>
095	<apip:magnification>
096	<apip:assignedSupport>>true</apip:assignedSupport>
097	<apip:activateByDefault>>true</apip:activateByDefault>
098	</apip:magnification>
099	<apip:backgroundColour>
100	<apip:assignedSupport>>true</apip:assignedSupport>
101	<apip:activateByDefault>>true</apip:activateByDefault>
102	<apip:colour>0000CC</apip:colour>
103	</apip:backgroundColour>
104	<apip:foregroundColour>
105	<apip:assignedSupport>>true</apip:assignedSupport>
106	<apip:activateByDefault>>true</apip:activateByDefault>
107	<apip:colour>FFFF33</apip:colour>
108	</apip:foregroundColour>
109	<apip:colourOverlay>
110	<apip:assignedSupport>>true</apip:assignedSupport>
111	<apip:activateByDefault>>true</apip:activateByDefault>
112	<apip:colour>CC99CC</apip:colour>
113	</apip:colourOverlay>
114	<apip:invertColourChoice>
115	<apip:assignedSupport>>true</apip:assignedSupport>
116	<apip:activateByDefault>>true</apip:activateByDefault>
117	</apip:invertColourChoice>
118	</apip:apipScreenEnhancement>

119	</screenEnhancement>
120	</display>
121	</accessForAllUser>

The key point is that, in general, the PNP consists of a set of ‘assignedSupport’ and ‘activateByDefault’ tuples for the range of alternative accessibility content that can be in an APIP Package. It is these values that must be used by the Assessment Delivery System to determine which alternative accessibility content is required by the user and whether or not this new content must be available as the default operational mode (as opposed to selected on demand).

2.6. Assessment Scoring Management System

The assessment scoring management system (ASMS) derives score, performance and feedback information for individual responses as well as collections of items in strands/sub tests and for the total assessment. The ASMS may use algorithms or lookup tables to derive alternate scores, such as scale-score or normative data. The ASMS may also determine student performance level information or mastery data. The ASMS must score a variety of item types such as multiple-choice, true/false, short response, etc. The ASMS implements various scoring algorithms and techniques such as matching, lookup, algorithmic (i.e. artificial intelligence) and human or distributed scoring in order to perform all scoring necessary. The ASMS may have to rely on a longitudinal data store in order to calculate growth scores. The ASMS must exchange data with the Test Bank as shown in Figure 2.11.

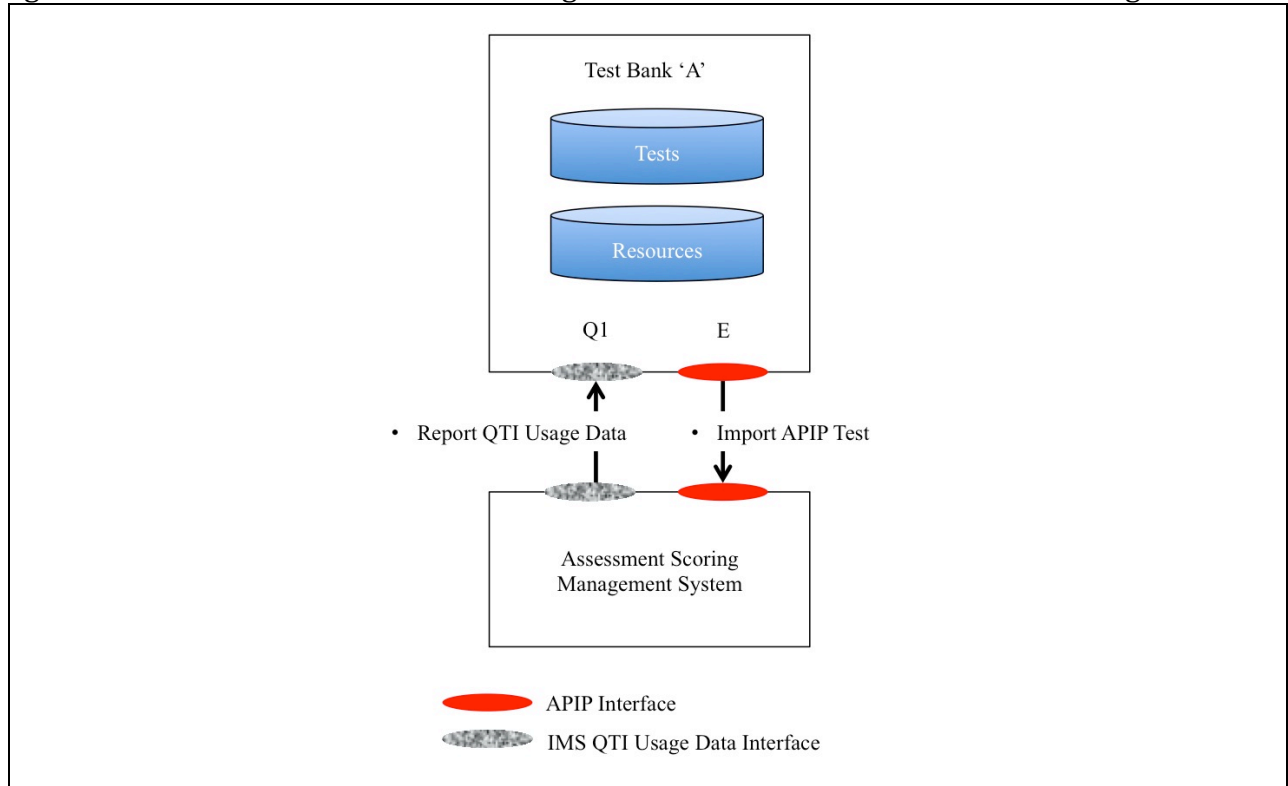
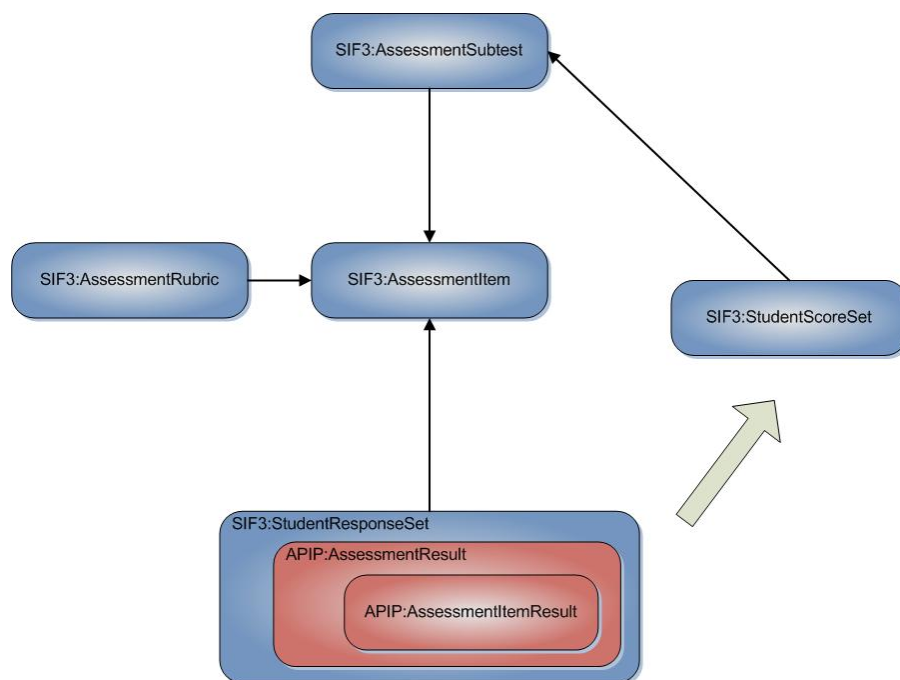

Figure 2.11 Test bank and assessment scoring management system interaction

Two APIs are required to support the exchange of data between a Test Bank and the ASMS:

- [E] The scoring parameters and models for the Item-level response processing, Item-level outcomes processing and Test-level outcomes processing are contained within the APIP Test Package;
- [Q1] The ASMS can return the corresponding usage data analytics, or item statistics, using the IMS QTI Usage Data entity [QTI, 06d] (this is not a part of the APIP specification). This includes the use of the corresponding set of glossary vocabularies for the set of permitted statistics. The appropriate set of item statistic terms must be agreed so that the relevant information can be collected.

2.6.1. SIF Provision for Scoring



Data Flow

- The Assessment Items and the Assessment Subtests are created during the development of the assessment. The Assessment Rubric is created in order to score individual items.
- When the student takes the assessment, the Student Response Set is created.
 - The Student Response Set contains the APIP Assessment Result data structure, the APIP Assessment Item Result data structure, as well as other related APIP formatted information.
 - The Student Response Set represents all the student's responses (in various modalities) to all the items on the assessment.
 - Items on the assessment may involve more than one response from the test taker.

- The Student Response Set is processed using algorithms or rule sets, as described above, to produce the Student Score Set.

2.7. Assessment Results Operational Reporting

The assessment results operational reporting system provides immediate results to users for a test administration. The assessment results operational system is not expected to derive any score data but may use score data to calculate summary information such as class/school averages. The assessment results operational system may provide print and online versions of the reports. The assessment results operational system provides data to other consuming systems as needed. This may require some reformatting or filtering of information (such as de-identification for research).

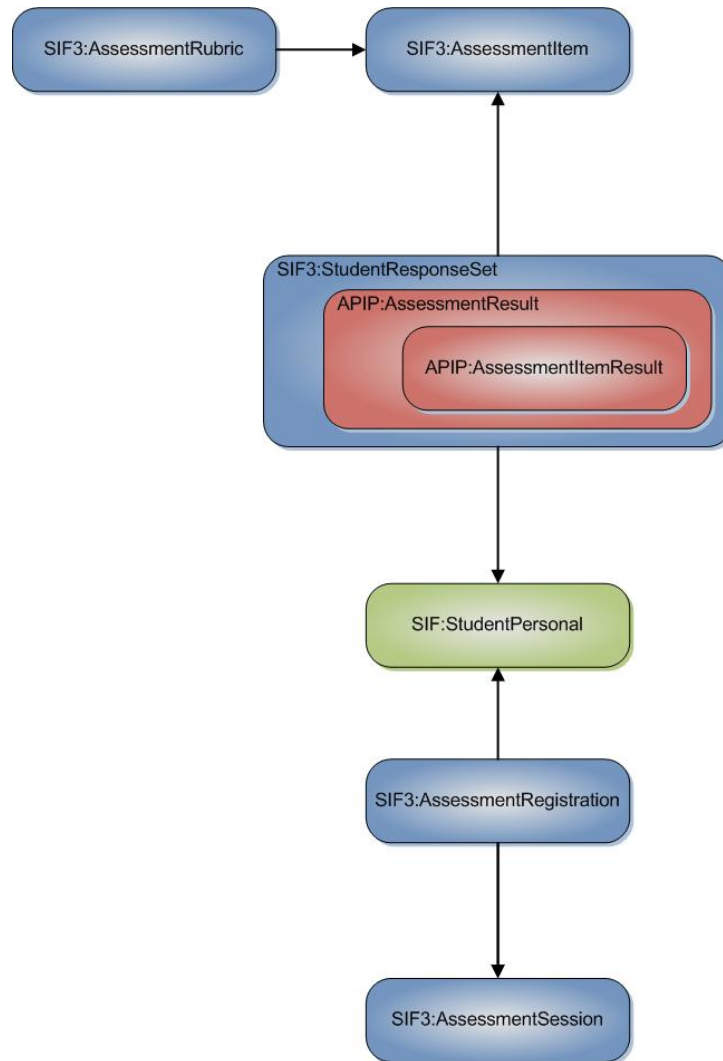

2.7.1. Data Flow

- Assessment Items and Assessment Rubrics are created during development of the assessment.
- Assessment Registration and Assessment session are created before the student takes the test.
- The Student Personal information is provided by a system external to the assessment system(s).
- As the student takes the test, partial or complete versions of the Student Response Set are created.
- Real-time feedback is passed back to the Assessment Registration and Administration System (ARAS) or summary feedback is passed to various reporting and storage functions.

2.7.2. Example XML Code

The exchange of these data, Arrow 8, is one of the areas where there is a combination of IMS Global and SIF data structures. An example of how this is achieved is shown in the code set below. The SIF 'StudentResponseSet' is the top-level container and the QTI additions are shown as the shaded lines. In this example, the data for a single True/False Item answered by the learner is reported.

```

001 <sif3:StudentResponseSet xmlns:xsi="http://www.w3.org/2001/XMLSchema-instance"
002   xmlns="http://www.sifinfo.org/infrastructure/sif"
003   xmlns:sif3="http://www.sifinfo.org/infrastructure/sif"
004   xmlns:qti="http://www.imsglobal.org/xsd/imsqti_result_v2p1"
005   xsi:schemaLocation="http://www.sifinfo.org/infrastructure/sif sif.xsd"
006   RefId="...SIF GUID..."
007   AssessmentAdministrationRefId="...SIF GUID..."
008   StudentPersonalRefId="...SIF GUID..."
009   AssessmentRegistrationRefId="...SIF GUID...">
010   <sif3:Items>
011     <sif3:Item AssessmentItemRefId="FFFFFFFFFFFFFFFFFFFFFFFF01">
012       <!-- NOTE: This will require the APIP AssessmentItem identifier to conform to the
013       SIF GUID format. -->
014       <sif3:Response>False</sif3:Response>
015       <sif3:ResponseCorrectness>incorrect</sif3:ResponseCorrectness>
016       <sif3:ViewStatus>yes</sif3:ViewStatus>
017       <sif3:AttemptStatus>yes</sif3:AttemptStatus>
018       <sif3:ItemNumber>1</sif3:ItemNumber>
019       <sif3:ItemName>APIPv1.0 Entry Profile Single T/F Item Test Instance
020       </sif3:ItemName>
021       <sif3:ItemScore>0</sif3:ItemScore>
022       <qti:assessmentResult>
023         <qti:context>
024           <qti:sessionIdentifier sourceID="???" identifier="???" />
025         </qti:context>
026         <qti:itemResult identifier="VE-IP-01" timestamp="2012-09-14T09:00:00"
027         sessionStatus="final" sequenceIndex="1">

```

028	<qti:responseVariable identifier="RESPONSE" cardinality="single">
029	<qti:correctResponse>
030	<qti:value>True</qti:value>
031	</qti:correctResponse>
032	<qti:candidateResponse>
033	<qti:value>False</qti:value>
034	</qti:candidateResponse>
035	</qti:responseVariable>
036	<qti:outcomeVariable identifier="SCORE" cardinality="single">
037	<qti:value>0</qti:value>
038	</qti:outcomeVariable>
039	<qti:outcomeVariable identifier="SCORE.NormalMinimum"
040	cardinality="single">
041	<qti:value>0</qti:value>
042	</qti:outcomeVariable>
043	<qti:outcomeVariable identifier="SCORE.NormalMaximum"
044	cardinality="single">
045	<qti:value>1</qti:value>
046	</qti:outcomeVariable>
047	</qti:itemResult>
048	</qti:assessmentResult>
049	</sif3:Item>
050	</sif3:Items>
051	</sif3:StudentResponseSet>

The SIF data provides the overall response information whereas the QTI provides the detailed information about the Item and its outcome variables.

2.8. Assessment Data Warehouse

The assessment data warehouse provides long-term data storage and aggregation of data to support business intelligence type of reporting. This data warehouse supplies reports to numerous other components within AIF.

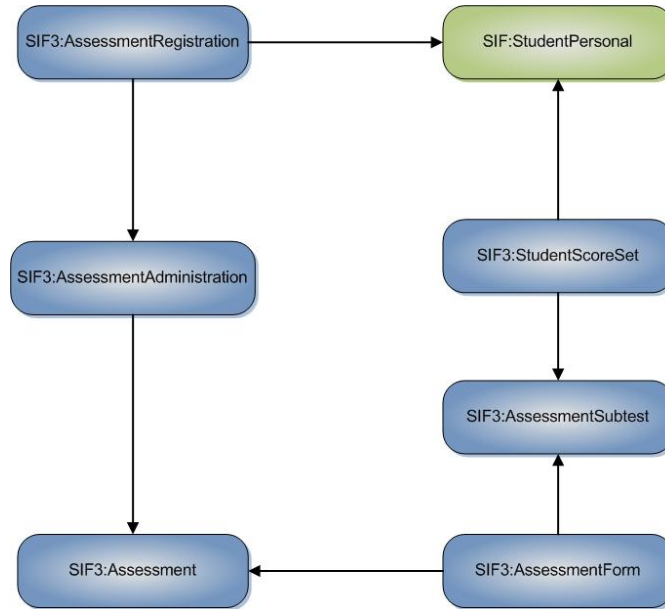

Data Flow

The flow of data into the assessment data warehouse can vary and is usually determined by specialized ETL (Extract/Transform/Load) tools and processes. After an assessment is designed and administered, information from multiple sources is combined in order to provide fast reporting of longitudinal, comparative, and cross-tabulated information.

2.9. Local: SIS, LMS, Grade Book, Reporting System

The SIS, LMS, Grade Book and Reporting System for local entities contribute the data for registration. In addition, these systems take information from the reporting and data warehouse systems for display and easy access for teachers, parents and other education stakeholders.

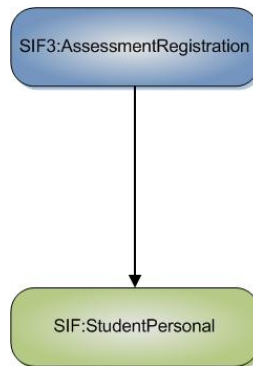

Data Flow

The SIS, LMS, Grade Book and Reporting System for local entities contribute the data for registration. In addition, these systems take information from the reporting and data warehouse systems for display and easy access for teachers, parents and other education stakeholders.

2.10. State, Consortia, SLDS, Accountability/AYP, Growth

The State, Consortia, SLDS, Accountability/AYP, and Growth Systems possess the same functionality and requirements as the local systems. For the Race to the Top Assessment Consortia, the student information comes from this system to populate the registration system. The flow of data and choreography is identical.

3. Supporting the Use Cases

Use cases developed to support the creation of the CEDS and AIF can be found at <https://ceds.ed.gov/pdf/aif-use-cases-v3.pdf>. The full demonstration prototype documentation can be found at XXX.

3.1. Assessment Item Bank Interoperability (Arrow 1)

The IMS APIP standard accounts for the interoperability of assessment item banks. The AIF vendors involved in implementing APIP face a variety of requirements and conditions related to their own systems and partner systems with which they sometimes interoperate. This variety leads to unique workflows and interactions that are covered within the scope of the standard.

A typical item bank interaction could consist of the following steps:

- Export Package Creation
 - **Export of Package**
 - **Package Receipt and Verification**
 - **Package Import**

This test scenario covers the following high-level test requirements:

- **Item authoring system**
- **Sending Item banking system**
- **Receiving Item banking system**

With the following users acting together:

- **Receiving Item Bank - Request specific items**
- **Sending Item Bank - Create export package of items**
- **Sending Item Bank -Export item package**
- **Receiving Item Bank - Import package and verify contents**
- **Receiving Item Bank - Import verified package to item bank**

Export Package Creation

The tester will access the sending item bank item data and will mark the requested items as appropriate in the item banking system for export to the receiving item bank. After logging into the sending item bank, the tester selects required items for export.

Export of Package

The tester will access the sending item bank item data and will create the physical export package. After logging into the sending item bank, the tester selects the appropriate package for export. The complete package of assessment content and associated supporting files is created in the pre-defined host transfer area.

Package Receipt and Verification

The tester will access the export and verify content of the package by accessing the transfer area and running validations on the package contents. If errors are encountered in the validation they will be discussed with the sending item bank and the resolved the package

will be re-exported. After logging into the secure transfer site and the appropriate package is selected, the package is transferred/downloaded to the receiving item bank. The package is then verified and validated by the IMS APIP package validation service.

Package Import

The tester will import the validated package into the receiving item bank. After logging into the receiving item bank, the package is successfully imported.

Demonstration Workflow

An example of the workflow described above is shown in Figure 3.1. This is a workflow that was also demonstrated, and is being used, between ETS and Measured Progress who are collaboratively creating APIP Items.

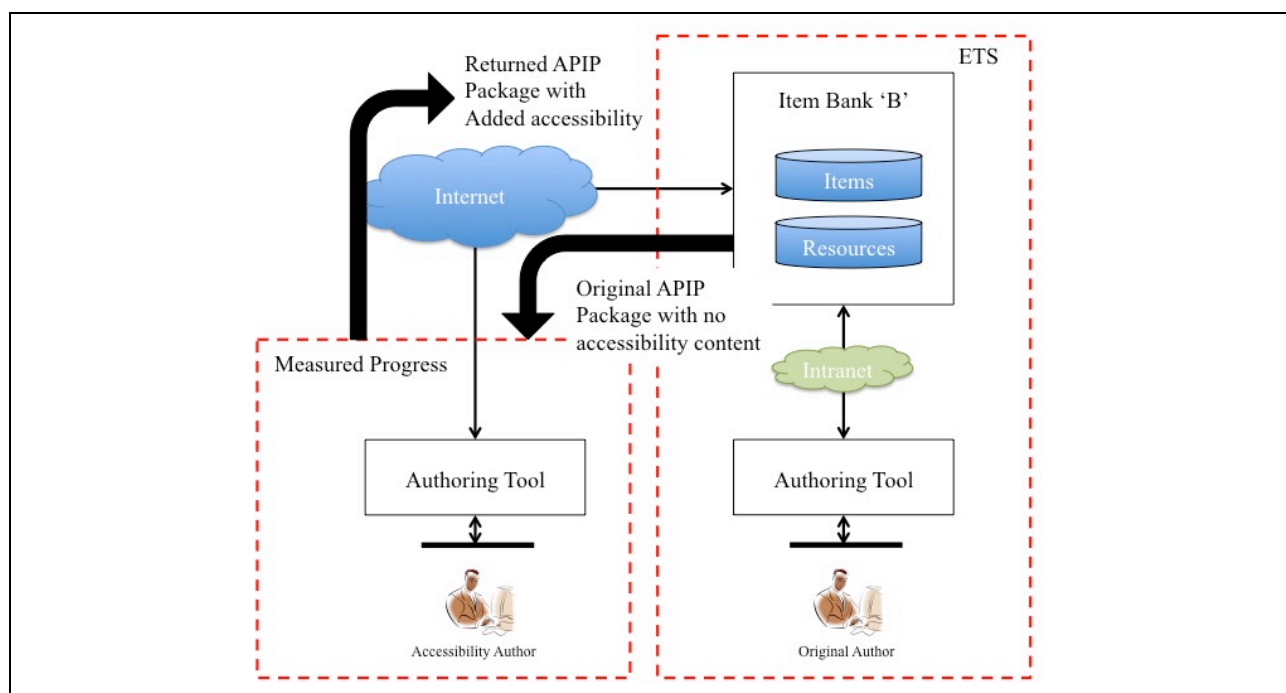

Figure 3.1 Demonstration workflow for arrow '1'

The workflow that is being used in Figure 3.1 is:

- The ETS content development team creates the original Item(s) and stores these as APIP Package(s) in their Item Bank (these packages conform to the APIP Entry Profile). These Item(s) have no accessibility material as this is to be added by Measured Progress. Once complete, ETS supplies Measured Progress with the identifiers of the APIP Packages ready for processing;
- Measured Progress downloads the APIP Packages and validates these to confirm that they are valid. If valid, Measured Progress uses a purpose built automated accessibility tool that adds the accessibility content to the original Items and then repackages these as new APIP Packages (these conform to the APIP Core Profile). Measured Progress then stores these new APIP Packages in the ETS Item Bank. These new packages contain all of the addition sound files;

- ETS then validates the new APIP Packages to confirm that they conform to the APIP Core Profile. These Item(s) are now available to the rest of the ETS Item development process.

3.2. Assessment Registration (Arrow 10)

The SIF Implementation Specification (US) 2.6 drives the interoperability for assessment registration. The IMS PNP is also necessary for accommodations. The AIF vendors involved in this demonstration prototype followed several steps:

- Export of student data
- Receipt and data quality verification
- Input of PNP data if necessary
- Create registrations for students

This test scenario covers the following high-level test requirements:

- **Student Information System (SIS) or Data Warehouse**
- **Assessment Registration System**

With the following users acting together:

- **Assessment Registration System – Request student information**
- **SIS or Data Warehouse – Creates export of student information**
- **Assessment Registration System – Imports student information and verifies data**
- **Assessment Registration System – PNP data is entered**
- **Assessment Registration System – Creates registrations for assessment**

Figure 3.2 provides a high-level overview of the process:

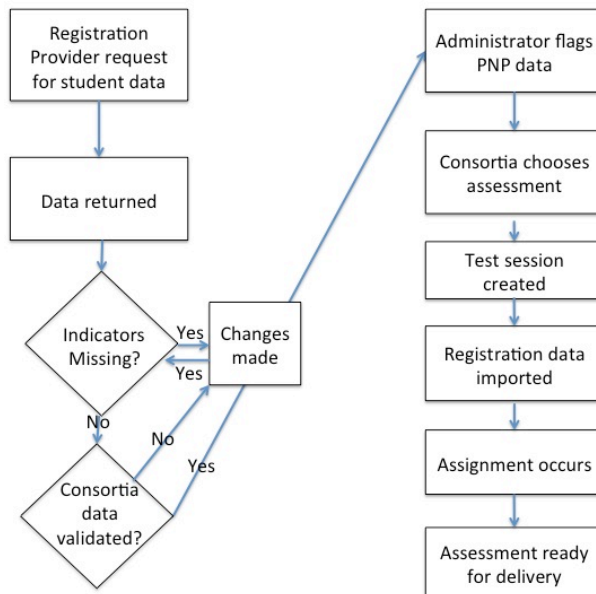

Figure 3.2 Assessment Registration Process

Export Student Data

The Assessment Registration System will request the necessary student information. The SIS or Data Warehouse compiles the necessary request and exports via batch file to the Assessment Registration System.

Receipt and Data Quality Verification

An acknowledgement of the receipt of the data occurs and a data quality check takes place. Any discrepancies or errors are corrected at this time.

Input PNP Data

An administrator enters in any necessary PNP data into the Assessment Registration System. These data follow the student for all components of the assessment and accommodations are made.

Create Registration

The Assessment Registration System generates registrations for specific administrations of the assessments.

3.3. Assessment Results Distribution to State Information Systems (Arrow 14)

The SIF Implementation Specification (US) 2.6 drives the interoperability for assessment reporting. The AIF vendors involved in this demonstration prototype followed several steps:

- Export of student results
- Receipt and data quality verification

This test scenario covers the following high-level test requirements:

- State or Consortium Data Warehouse
- Assessment Reporting System

With the following users acting together:

- Assessment Reporting System – Signals that reporting data is ready to
- Data Warehouse – Requests the necessary data
- Assessment Reporting System – Sends reporting data
- Data Warehouse – Imports reporting data and processes

Figure 3.3 provides a high-level view of the process:

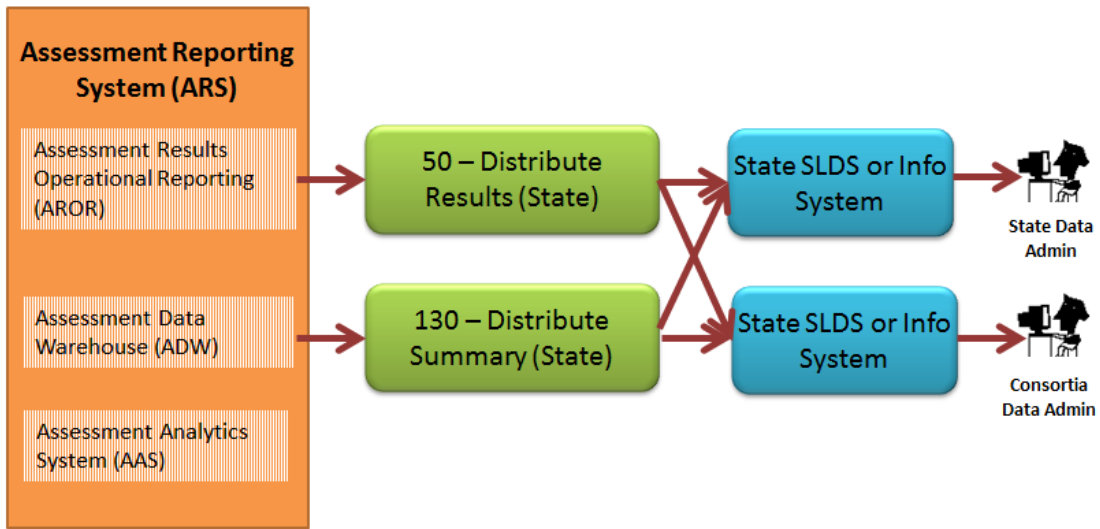

Figure 3.3: Assessment Reporting System to Data Warehouse

Export Student Results

The Assessment Reporting System sends a message that reporting results are ready. The Data Warehouse requests the reporting data. The Assessment Reporting System packages up the necessary data and sends the results to the Data Warehouse.

Receipt and Data Quality Verification

The Data Warehouse acknowledges the receipt of the data and verifies them. The Data Warehouse then processes and displays the data as required by the business drivers and requirements.

4. Acronyms and Glossary

AfA	Access for All
APIP	Accessible Portable Item Profile
ARAS	Assessment Registration and Administration System
ASMS	Assessment Scoring Management System
CCSS	Common Core State Standards
CEDS	Common Education Data Standards
CSM	Curriculum Standards Metadata
CSS	Cascading Stylesheets
HTML	Hypertext Markup Language
IMS Global	IMS Global Learning Consortium
JSON	Java Script Object Notation
PNP	Personal Needs and Preferences
QTI	Question & Test Interoperability
REST	Representational State Transfer
SIF	Schools Interoperability Framework
SIS	Student Information System
SOAP	Simple Object Access Protocol
XHTML	Extensible Hypertext Markup Language
XML	Extensible Markup Language